



G7 4K ULTRAHD

**SDI/HDMI ON CAMERA Monitor
User Manual**

OSEE OSEE TECHNOLOGY LTD.

Product Information

Model: G7 4K ULTRAHD SDI/HDMI ON CAMERA Monitor
Version: V010004
Release Date: July19th, 2022

Company
OSEE TECHNOLOGY LTD.

Contact Information

OSEE TECHNOLOGY LTD.

Address: No.22 Building, No.68 zone, Beiqing Road, Haidian District, Beijing, China
Post Code: 100094
Tel: (+86) 010-62434168
Fax: (+86) 010-62434169
Web: <http://www.osee-dig.com/>
E-mail: sales@osee-dig.com

About this manual

Important

The following symbols are used in this manual:

Tips

- The further information or know-how for described subjects above which helps user to understand them better.
-

Warning

- The safety matters or operations that user must pay attention to when using this product.
-

Contents

The user manual applies to the following device types:

- **G7 4K ULTRAHD**

The images and descriptions of G7 4K ULTRAHD are adopted as examples in the following document.

Before reading the manual, please confirm the device type.

Contents

Contents	1
Chapter 1 Overview	1
Chapter 2 Safety	3
Chapter 3 Unpack and Installation	7
Chapter 4 Features	11
4.1 Parts and Functions	11
4.2 Buttons and Functions	12
4.3 Operations	13
4.4 Power On	15
4.5 ZOOM	17
4.6 Supported Signal Format	19
Chapter 5 Monitor Settings	23
5.1 Menu Operations	24
5.2 Monitor Menu	25
5.2.1 INPUT.....	25
5.2.2 Controls	25
5.2.3 User	32
5.2.4 System	33
Chapter 6 Scenes and Tools	41
6.1 Scenes Tools Settings	41

6.1.1	Frame Tools	43
6.1.2	Expose Tools.....	47
6.1.3	Focus Tools.....	55
6.1.4	Look Tools.....	58
6.1.5	Scale Tools.....	62
6.2	Tools Operations	64
6.2.1	Add a Scene.....	64
6.2.2	Delete a Scene.....	65
6.2.3	Add a Tool.....	66
6.2.4	Load/Close Tool Bar	69
6.2.5	Open/Close a Tool	70
6.2.6	Tool Settings	71
6.2.7	Delete a Tool.....	73
Chapter 7	Specifications	77
7.1	Product detailed information	77
7.2	Dimensions	79

Chapter 1 Overview

G7 4K ULTRAHD is a high-performance UHD SDI/HDMI On Camera Monitor to monitor photography and videography professionally especially in outdoor.

The unit is designed in a high impact plastic frame, and the professional screen glass at full resolution of 1920x1200 with high brightness makes G7 4K ULTRAHD capable of reproducing a natural color and great daylight viewing. In addition, the monitor has excellent assistant functionalities, versatile built-in 3D-LUTs and easy to use.

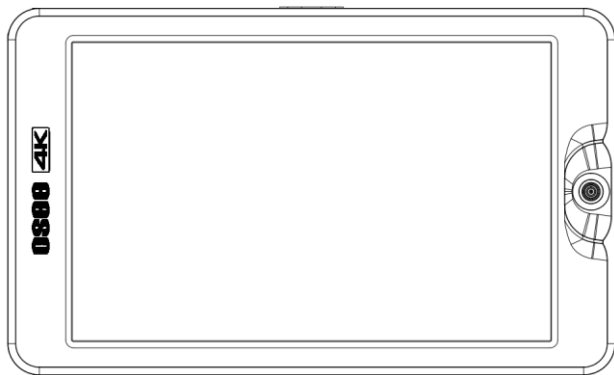

Figure 1-1 A Diagram of G7 4K ULTRAHD

Features

- Support 2K SDI input and 4K HDMI input
- Support output to external cameras, such as SONY, Panasonic, Canon etc.
- Support high qualified waveform, vector scope, histogram and audio meter

- Support multiple assistants: zebra, focus assist, exposure assist, peaking adjust
- Provide a five-direction joystick as a navigation tool to scroll between scene pages and set features
- Support SONY NP-F series batteries

Functionality

- Provide versatile built-in 3D-LUT tables, supporting the general LUT files for ARRI, RED, SONY, Panasonic, Canon, BlackMagic and Panavision, etc. And you can upload custom 3D-LUTs through SD card and apply to the monitor
- Support Anamorphic Desqueeze functionality in multiple modes: 1X, 1.33X, 1.5X, 1.66X, 1.8X, 2X, 2XMAG
- Support Image ZOOM functionality to double(2X) or quadruple(4X) the image, and to pan the image in every direction

Chapter 2 Safety

FCC Caution:

Any changes or modifications not expressly approved by the party responsible for compliance could void the user's authority to operate the equipment.

This device complies with part 15 of the FCC Rules.

Operation is subject to the following two conditions: (1) This device may not cause harmful interference, and (2) this device must accept any interference received, including interference that may cause undesired operation.

Note: This equipment has been tested and found to comply with the limits for a Class B digital device, pursuant to part 15 of the FCC Rules. These limits are designed to provide reasonable protection against harmful interference in a residential installation. This equipment generates uses and can radiate radio frequency energy and, if not installed and used in accordance with the instructions, may cause harmful interference to radio communications. However, there is no guarantee that interference will not occur in a particular installation. If this equipment does cause harmful interference to radio or television reception, which can be determined by turning the equipment off and on, the user is encouraged to try to correct the interference by one or more of the following measures:

Reorient or relocate the receiving antenna.

Increase the separation between the equipment and receiver.

Connect the equipment into an outlet on a circuit different from that to which the receiver is connected.

Consult the dealer or an experienced radio/TV technician for help.

Warnings:

Read, keep and follow all of these instructions for your safety. Heed all

warnings.

Warning

Device

- Install in accordance with the manufacturer's instructions.
 - Do not touch the screen with sharp, metallic or abrasive objects.
 - Do not make the freeze picture displaying on the screen too long, otherwise, it will leave the afterimage on the screen.
 - If the brightness is adjusted to the minimum, then it might be hard to see the display screen.
 - Clean only with dry cloth.
 - Do not block any ventilation openings. Leave enough space around the unit for ventilation.
 - Do not expose to strong electrical or magnetic fields.
 - To reduce the risk of fire or electric shock, do not expose the unit to rain or moisture.
 - If the product needs replacement parts, make sure that the service person use replacement parts specified by the manufacture, or those with the same characteristics and performance as the original parts. Use of unauthorized parts can result in fire, electric shock and/or other damage.
 - The panel used in this produce is made of glass. Therefore, it can break when it is dropped or applied with impact. Be careful not to be injured by broken glass pieces.
 - Refer all servicing to qualified service personnel.
 - Specifications are subject to change without notice.
-

Warning

- Do not use attachments or accessories not recommended by the manufacture. Use of inadequate attachments may result in

serious accidents.

- Do not damage the power cord, place heavy objects on the power cord, stretch the power cord, or bend the power cord.
 - Protect the power cord from being walked on or pinched, particularly at plugs, convenience receptacles, and the point where they exit from the unit.
 - Please remember that almost all HDMI cables do not use locking connectors and will simply be pulled out if they are jerked or tripped over. Please ensure that your cables make a secure connection and avoid flexing them excessively to maintain reliability.
-

Chapter 3 Unpack and Installation

Unpack:

When unpacking the G7 4K ULTRAHD monitor, please verify that none of the components listed in Table 3.1 are damaged or missing. If there are any components missing, please contact your distributors or OSEE for it.

Table 3-1 Packing List

No.	Item	Quantity
1	G7 4K ULTRAHD	1
2	AC power adapter	1
3	D-tap to DC IN Cable	1
4	Sunhood	1
5	Battery Plate	1
6	Articulating Arm	1
7	Carry Case	1
8	Operation Manual	1
9	Service Card	1

Installation:

1. Prepare for installation

Please follow the procedures below before installing G7 4K ULTRAHD:

- Check the package and equipment for any visible damage that may have occurred during transit.

- Confirm all the items listed on the packing list have been received.
- Remove all the packing material including electrostatic-resistant packing.
- Retain these packing materials for future use.

2. Connect required cables for signal input and output.

3. Connect the 11~17VDC power source through DC IN interface or power the monitor by battery.

4. As a final step, turn on the device by toggling the power switch located on the rear of the unit.

Install Battery:

Only support SONY NP-F series currently. Please take note of the battery installation direction according to the “NP-F” icon near the slot when mounting the battery. The icons are as shown in the following illustration, slide the battery down into the slot until a click is heard.

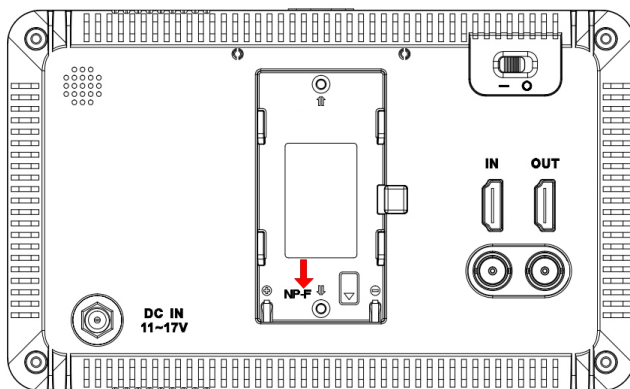

Figure 3-1 Battery Installation

Install Sunhood:

In case of diffusion light and direct illumination, we can use sunhood for the monitor when monitoring images.

First, spread the sunhood along the fold lines, then pull the rubber belts into the depressed slots at both sides of the rear panel of the monitor, adapt the sunhood to the monitor tightly as below:

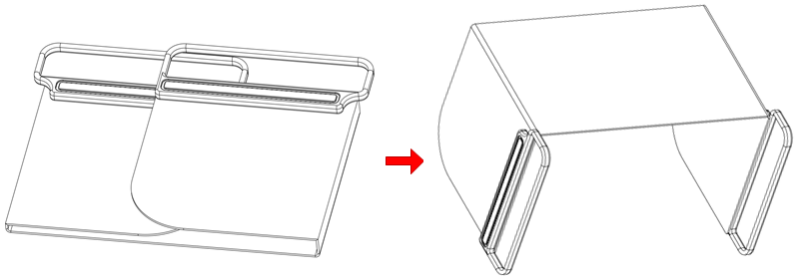

Figure 3-2 Spread Sunhood

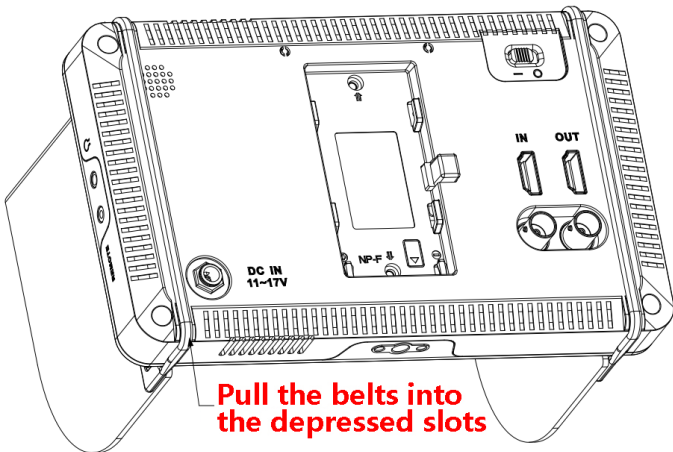

Figure 3-3 Fasten the Belts

Hanger Installation:

There are two 1/4 inch screw holes on the monitor for installing various types of hangers, as shown in the illustration below. Screw the hanger into the screw hole, and fasten it tightly.

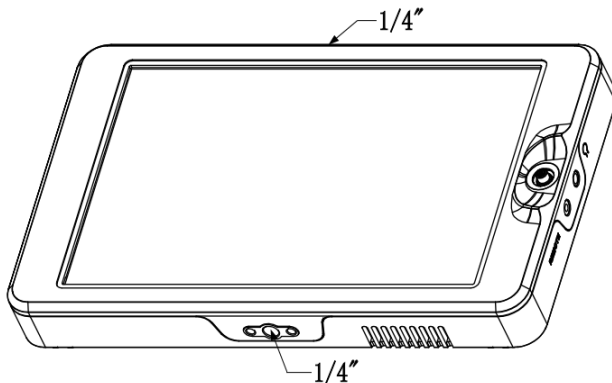

Figure 3-4 *Positions for Hanger Installation*

Tips

- Connect a standard signal line to the relevant input port.

Chapter 4 Features

4.1 Parts and Functions

The parts of G7 4K ULTRAHD is shown as below, there are various input and output interfaces for G7 4K ULTRAHD monitor, as shown in Figure 4.1-1.

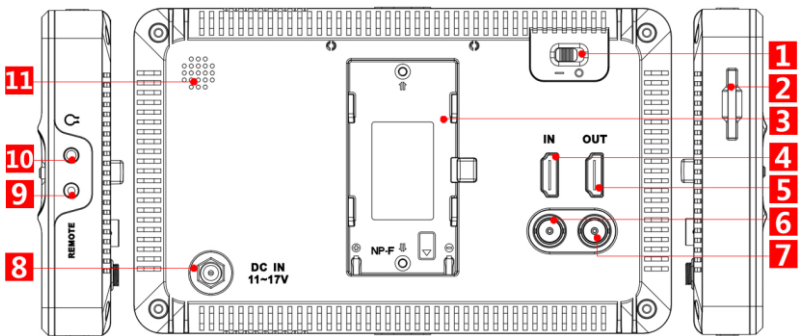



Figure 4.1-1 Parts in Rear Panel

No.	Connector	Description
1	Power Switch	Switch to “ ” position to power on; and switch to “○” position to power off
2		SD card slot, the SD card is used to load the customized LUT tables, and update firmware.
3	HDMI IN	HDMI input interface, supports HDCP, compatible DV11.0, HDMI Type-A
4	HDMI OUT	HDMI output interface, supports HDCP, compatible DV11.0, HDMI Type-A, supports loop out

No.	Connector	Description
5	SDI IN	SDI input interface, BNC
6	SDI OUT	SDI output interface, BNC, supports loop out
7	Battery Input	External battery NP-F, 6V ~ 8.4V
8	DC IN	DC power input, 11~17VDC
9	Remote	Remote control, 2.5mm Jack
10		Headphone output jack, 3.5mm stereo Jack
11	Fan	Internal fan

* Support SONY NP-F battery currently.

4.2 Buttons and Functions

The monitor provides a Joystick at the front panel, as shown in Figure 4.2-1. It is used for monitor settings, adding tools for scenes, tool settings, zoom image and so on.

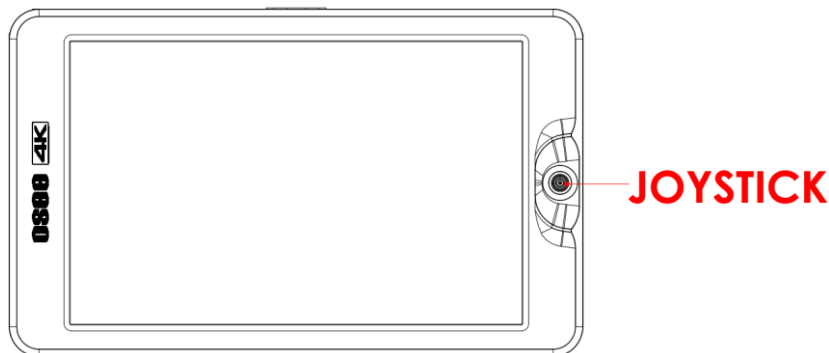

Figure 4.2-1 Buttons in Front Panel

4.3 Operations

Joystick

Use the joystick as a navigation tool to scroll between scenes and set features. The joystick provides multiple functions with five operation directions, **Up**, **Down**, **Left**, **Right** and **Straight Down**, as shown in Figure 4.3-1.

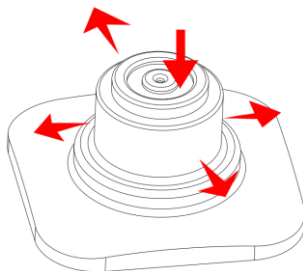

Figure 4.3-1 Five Operation Directions for Joystick

◀: scroll it left once to go to the previous scene if there is one,

scroll it left and hold for 3 seconds to access the monitor settings menu

: scroll it right once to go to the next scene if there is one, scroll it right and hold for 3 seconds to create a new scene

: access ZOOM mode

: scroll it down and hold on for 3 seconds to delete current scene

: press it straight down to display the scene TOOL menu

Direction	Operation
UP	<p>Without any menu, scroll up to access ZOOM mode. Keep scrolling up, and switching among these three modes FULL→2X→4X;</p> <p>In ZOOM 2X or ZOOM 4X editing mode, scroll up the joystick to move the starting position of the enlarged image;</p> <p>In monitor settings, scroll up to select the previous item or increase the item value;</p> <p>In scene tool menu, scroll up to select the previous item or increase the item value.</p> <p>In scene deletion mode, scroll up to close the scene deletion prompt (No.1 scene can't be deleted).</p>
DOWN	<p>In ZOOM mode, scroll down to exit ZOOM mode.</p> <p>In ZOOM 2X or ZOOM 4X editing mode, scroll down the joystick to move the starting position of the enlarged image;</p> <p>In monitor settings mode, scroll down to select the next item or decrease the item value;</p> <p>In scene tool menu, scroll down to select the next item or decrease the item value;</p> <p>In scene page, scroll down and hold for 3 seconds to prompt the scene deletion command.</p>
LEFT	<p>Without any menu, scroll left and hold for 3 seconds to access the monitor settings menu;</p>

Direction	Operation
	<p>In ZOOM 2X or ZOOM 4X editing mode, scroll left the joystick to move left the starting position of the enlarged image;</p> <p>In monitor settings mode, scroll left to return to the previous level menu, or decrease the item value;</p> <p>In a tool bar of a scene, scroll left to return to the previous level menu or the downward adjustment the item value.</p>
RIGHT	<p>Without any menu, scroll right to switch to the next scene, or scroll right and hold for 3 seconds to create a new scene;</p> <p>In ZOOM 2X or ZOOM 4X editing mode, scroll right to move right the starting position of the enlarged image;</p> <p>In monitor settings menu, scroll the joystick right to access the next level menu, or increase the item value;</p> <p>In a tool bar of a scene, scroll right to access the next level menu or the upward adjustment the item value.</p>
STRATIGHT DOWN	<p>In ZOOM 2X or ZOOM 4X mode, press straight down to access editing mode where the zoomed image can be panned up/down/right/left; In ZOOM 2X or ZOOM 4X editing mode, press straight down to exit editing mode;</p> <p>In a scene, press straight down to display the Tool menu;</p> <p>In a tool bar of a scene, press straight down the joystick to enable or disable the selected tool;</p> <p>In monitor settings menu, press straight down the joystick to access the next level menu, or confirm the selection of the last level menu item and return to the previous level menu.</p>

4.4 Power On

The power switch is on the right corner of the rear panel of G7 4K ULTRAHD. Use it to power the G7 4K ULTRAHD on or off.

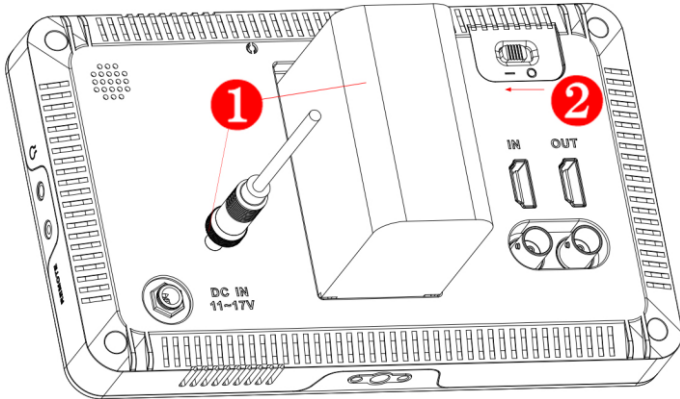

Figure 4.4-1 Power Switch

■ Power Method

There are two methods for powering G7 4K ULTRAHD as below:

Method 1: Powered by battery. There is a built-in battery slot at the rear panel of the monitor. It supports SONY NP-F series batteries. (6V~8.4V)

Method 2: Powered by DC power input. Use smart phone charger or power bank to connect external power through the DC IN interface. (11~17VDC)

■ Power On Operation

First, install the battery or connect the power cord.

Second, switch the power switch to “|” position, the device is powered on.

Tips

- It will display the boot screen after being powered on for 3~4 seconds.

- Only use the adapter and the power cord specified by the manufacture for your safety!

4.5 ZOOM

You can get a closer view of your image in ZOOM mode. It provides 2X and 4X ZOOM mode, which means you can double(2X) or quadruple(4X) the image, and move the starting position of the enlarged image.

1. ZOOM 2X

■ Enter Zoom 2X Mode

Scroll up the joystick to access **Zoom 2X** mode, the image is twice as large as the original one. There will be a Zoom 2X icon at the bottom right of the screen, as shown in Figure 4.5-1



Figure 4.5-1 Zoom 2X Mode

■ Zoom 2X Editing Mode

After accessing the Zoom 2X Mode, press the joystick straight down to move the starting position of the enlarged image.

There will be a Zoom 2X Editing icon at the bottom right of the screen, as shown in Figure 4.5-2. The small rectangle with four direction arrows in this icon represents the current full screen image, you can judge where this area is in the original image.

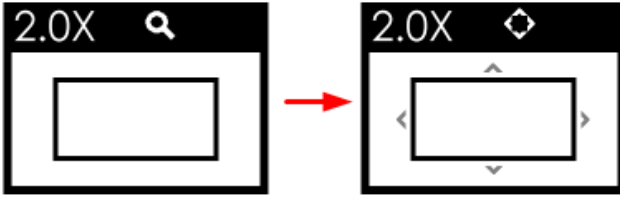

Figure 4.5-2 Zoom 2X Editing Mode

■ Moving the zoomed image

Meanwhile, scroll the joystick up, down, left or right to move the displayed area to the relevant direction, then, press the joystick straight down to confirm and finish the movement and exit the Zoom 2X Editing mode.

2. ZOOM 4X

■ Enter Zoom 4X Mode

Scroll up the joystick to show the **Zoom 2X** mode, and then keep scrolling up the joystick to show the **Zoom 4X** mode, the image is four times as large as the original one. There will be a Zoom 4X icon at the bottom right of the screen, as shown in Figure 4.5-3:



Figure 4.5-3 Zoom 4X Mode

■ Zoom 4X Editing Mode

After accessing the Zoom 4X Mode, press the joystick straight down to access Zoom 4X Editing Mode.

There will be a Zoom 4X Editing icon at the bottom right of the screen, as shown in Figure 4.5-4. The small rectangle with four direction arrows in this icon represents the current full screen image, you can judge where this area is in the original image.

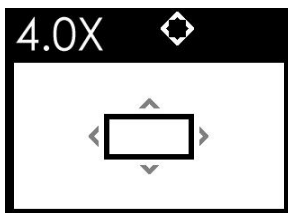

Figure 4.5-4 Zoom 4X Editing Mode

■ Moving the zoomed image

As the same as Zoom 2X editing mode, scroll the joystick up, down, left or right to move the displayed area to the relevant direction, then, press the joystick straight down to confirm and finish the movement and exit the Zoom 4X Editing mode.

3. Original Image Mode

■ Original Image Mode

In Zoom 2X mode or Zoom 4X mode, press the joystick straight down, it will recover and display the original image.

Tips

- The scene tools are not editable in ZOOM 2X or ZOOM 4X mode.

4.6 Supported Signal Format

The supported signal format for this device is as shown in Table 4.6-1:

Table 4.6-1 Supported Signal Format

Signal Format		HDMI	SDI
4K	4KP30/29.97	✓	
	4KP25	✓	
	4KP24/23.98	✓	
2K	1080P60/59.94		✓
	1080P50		✓
2160P	2160P30/29.97	✓	
	2160P25	✓	
	2160P24/23.98	✓	
1080P	1080P60/59.94	✓	✓
	1080P50	✓	✓
	1080P30/29.97	✓	✓
	1080P25	✓	✓
	1080P24/23.98	✓	✓
1080I	1080I60/59.94	✓	✓
	1080I50	✓	✓
1080SF	1080SF30/29.97		✓
	1080SF25		✓

Signal Format		HDMI	SDI
	1080SF24/23.98		✓
1035I	1035I60/59.94		✓
720P	720P60/59.94	✓	✓
	720P50	✓	✓
	720P30/29.97		✓
	720P25		✓
	720P24/23.98		✓
576P50	576P50	✓	
480P60	480P60	✓	

Chapter 5 Monitor Settings

This chapter describes the structure and functionality of the monitor settings, and introduces how to modify and customize the monitor settings.

Monitor settings contains the settings of input, volume, backlight, display rotate, anamorphic, DSLR scale, status display menu, LUTs, language, firmware and so on, as shown in Figure5-1.

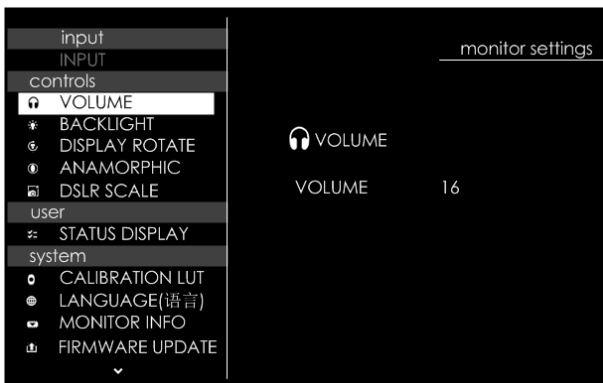

Figure 5-1 Monitor Settings Menu

The features on the screen are as shown in Figure 5-2:



Figure 5-2 Tools for G7 4K ULTRAHD Monitor

And there could be multiple accessorial objects on screen, such as status display information, aspect area, safe area, crosshair, waveform, audio meter, histogram, focus assist, false color and so on.

Please refer to the relevant sections for the details in this chapter.

5.1 Menu Operations

Display the Monitor Settings Menu

Scroll the **Joystick** left and hold for 3 seconds to display the monitor settings Menu, as shown in Figure 5.1-1:

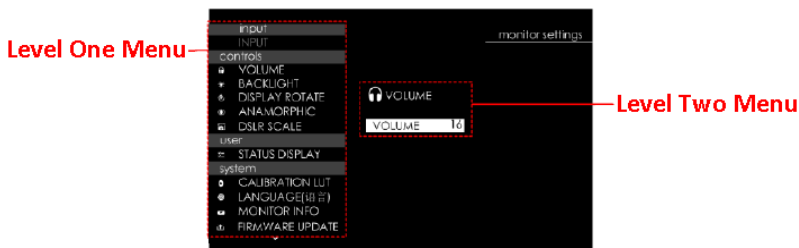

Figure 5.1-1 the Structure of the Monitoring Settings Menu

The menu interface is divided into two parts: **Level one menu** and **Level two menu**. Follow the instructions below:

Menu List for Monitor Settings

The level one menu is the main menu list for monitor settings, including **input output, controls, user, and system**.

Scroll the **Joystick** up and down to navigate through the level one menu of the monitor settings and select a menu item. The selected menu item will be highlighted in a control icon.

Submenu for Monitor Settings

The details of the selected menu item is located at the center right of the screen. You can check the content of the current menu item.

Press the joystick straight down after selecting a Level 1 menu item, it will access the level two menu page, and the control icon follows. Then, scroll

up or down to select the submenu item, after that, scroll left or right to switch or adjust the value of the selected submenu item, at last, press straight down to return to the previous level menu and confirm the setting.

Tips

- The control icon is displayed as a highlight white rectangle at the background of the current active item.

5.2 Monitor Menu

The following will introduce the contents and functionality of these menu items in sorts.

5.2.1 INPUT

The **INPUT** menu provides HDMI&SDI input, as shown in Table 5.2-1:

Table 5.2-1 Description of INPUT Menu

Menu	Items	Description
INPUT	HDMI/SDI	Select the input signal source

Tips

- The output will be synchronized with the input automatically.

5.2.2 Controls

The **CONTROLS** menu items are used to adjust volume, backlight, rotating image, and set anamorphic ratio and image size from DSLR device. The menu items are as shown in Figure 5.2-1:



Figure 5.2-1 Controls Menu

Table 5.2-2 Description of Controls Menu Items

Menu	Items	Default	Domain Range	Description
VOLUME	VOLUME	16	0~31	Adjust the volume
BACKLIGHT	BACKLIGHT	5	0~10	Adjust the backlight
	AMBIENT TEMP	30C /86F	25C/77F 30C/86F 35C/95F 40C/104F	Set the ambient temperature according to actual working environment, in order to start the monitor fan in a proper speed in case of overheating
DISPLAY ROTATE	SCREEN ROTATE	AUTO	AUTO/0/180	Rotate the image and menus
	IMAGE ROTATE	180	0/180	Rotate the image
ANAMORPHIC	OPTIONS	1X	1X/1.33X/ 1.5X/1.66 X/1.8X/2X/ 2XMAG	Set the anamorphic ratio
DSLR SCALE	OPTIONS	NONE	NONE/ CANON 5D MARK	Enable the input signal from a variety of DSLR cameras to fill the screen of G7 4K

Menu	Items	Default	Domain Range	Description
			II/CANON 7D	ULTRAHD. This item is particularly to CANON/NIKON DSLR.

1. Adjust Volume

Select **control**→**VOLUME** item, press straight down to confirm the selection and display the VOULME menu, as shown in Figure 5.2-2. Scroll left to decrease the volume, or scroll right to increase the volume. Press the joystick straight down to return to the previous level menu.



Figure 5.2-2 Volume Menu

2. Adjust Backlight

The monitor supports fan control to adjust the device temperature.

The fan speed depends on the selected ambient temperature and backlight. There are four gears (1~4 in increasing order) for the fan speed control, the higher the fan gear is, the faster the fan runs. The relationship is as shown in the table below:

AMBIENT BACKLIGHT	25°C/77°F	30°C/86°F	35°C/95°F	40°C/104°F
0~6	OFF	OFF	OFF	OFF
7	OFF	OFF	OFF	1

AMBIENT BACKLIGHT	25°C/77°F	30°C/86°F	35°C/95°F	40°C/104°F
8	OFF	OFF	1	2
9	OFF	1	2	3
10	OFF	1	2	4

■ BACKLIGHT

Select **control**→**BACKLIGHT** → **BACKLIGHT** item, press straight down to confirm the selection and display the BACKLIGHT menu, as shown in Figure 5.2-3. Scroll left to decrease, right to increase the backlight. Besides, scroll down to display the Backlight menu directly in a scene, then scroll up to exit this menu.

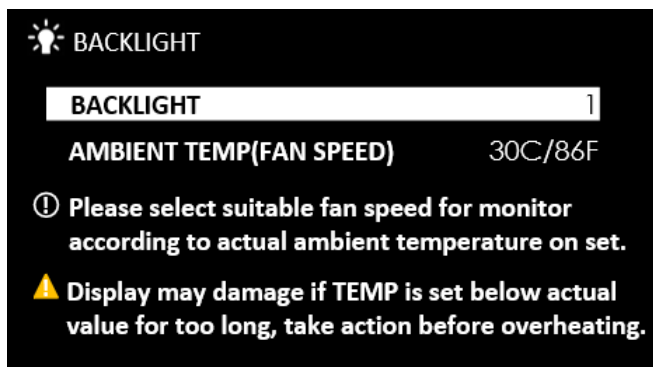

Figure 5.2-3 Backlight Menu

■ AMBIENT TEMP (FAN SPEED)

Select **control**→**BACKLIGHT** →**AMBIENT TEMP** item to set the preset of ambient temperature for the monitor. Press straight down to confirm the selection, and scroll left or right to select a temperature preset.

After setting the ambient temperature, the monitor will run in a proper fan speed when you adjust the backlight of the device. The

relationship of the fan speed, ambient temperature and backlight degree is as shown in the above table.

Warning

- Display may damage if TEMP is set below actual value for too long, select a higher value for AMBIENT TEMP or shut the monitor down before overheating!

3. Display Rotate

■ Screen Rotate

Set **control**→**Display Rotate**→ **Screen Rotate** item to be **180, 0** or **AUTO**, the input image will reverse vertically with the menus, as shown in Figure 5.2-4:



Original Image

Reverse Image

Figure 5.2-4 Vertical Rotate

■ Image Rotate

Set **control**→**Display Rotate**→ **Image Rotate** item to be **180** or **0**, the input image will reverse vertically.

4. Set Anamorphic Ratio

This feature enables you to de-squeeze signals coming from camera utilizing anamorphic lenses that may not have a built-in de-squeeze

feature of their own. This is quite useful in applications, such as outdoor post production, onset monitoring, real-time de-squeezing, etc.

Select **control**→**ANAMORPHIC** item, press straight down to confirm the selection and display the **ANAMORPHIC**, as shown in Figure 5.2-5, scroll left or right to cycle through these anamorphic ratios: 1X, 1.33X, 1.5X, 1.66X, 1.8X, 2X, 2XMAG.



Figure 5.2-5 ANAMORPHIC Menu

The resolution of the input and output are as shown in Table 5.2-3:

Table 5.2-3 Resolution Relationship Between Input and Output

ANAMORPHIC	INPUT SIGNAL	INPUT	OUTPUT
1X	1080P/1080I	1920x1080	1920x1080
	720P	1280x720	1920x1080
1.33X	1080P/1080I	1920x1080	1920x812
	720P	1280x720	1920x812
1.5X	1080P/1080I	1920x1080	1920x720
	720P	1280x720	1920x720
1.66X	1080P/1080I	1920x1080	1920x650
	720P	1280x720	1920x650
1.8X	1080P/1080I	1920x1080	1920x600
	720P	1280x720	1920x600
2X	1080P/1080I	1920x1080	1920x540

	720P	1280x720	1920x540
2XMAG	1080P/1080I	1290x720	1920x803
	720P	860x720	1920x803

5. DSLR SCALE

This function is designed for some DSLR cameras (CANON 5D MARK II, CANON 7D). The valid area which will fill the screen is controlled by **control**→**DSLR SCALE** item selection.

When the input source is coming from CANON 5D MARK II or CANON 7D DSLR device, but the **control**→**DSLR SCALE** item is set as **NONE**, the **DSLR SCALE** function is disabled, there will be blank area at the surrounding of the image. Otherwise, set as the relevant DSLR model, it will enlarge and display the image at full screen, removing those useless blank bars, as shown in Figure 5.2-6:



Figure 5.2-6 DSLR SCALE

For different **DSLR SCALE** item value, the resolution comparison of the input and output is as shown in the table below:

DSLR SCALE Item	INPUT RESOLUTION	OUTPUT RESOLUTION
NONE	1920X1080	1920x1080
CANNON 5D MARK II	(1920X1080)x0.85	1920x1080

CANNON 7D	(1920X1080) x0.85	1920x1080
-----------	-------------------	-----------

5.2.3 User

The menu items of **User** menu are as shown in Figure 5.2-7:



Figure 5.2-7 User Settings Menu

Table 5.2-4 Description of User Menu Items

Menu	Items	Default	Domain Range	Description
STATUS DISPLAY	OPTIONS	OFF	OFF/ON/ BAT ONLY	Change the status bar at the top of the screen

1. STATUS BAR

Set **user**→**STATUS DISPLAY** item to be **ON**, it will display the Status bar at the top of the screen, including these information from left to right: Input source format and the battery voltage indication.

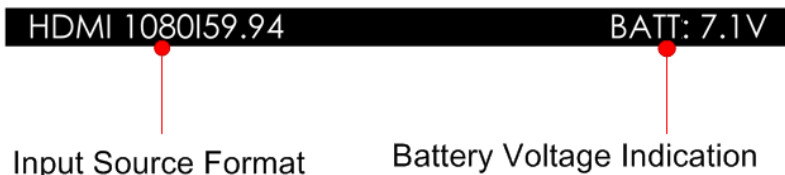

Figure 5.2-8 Status Bar

■ INPUT FORMAT

The **Signal Format** usually displays as the following situations:

- UNKNOWN**: appears if an unsupported signal is input.

- ❑ **NO SIGNAL:** appears if no signal is detected.
- ❑ **Normal:** the signal format is displayed as HDMI 1080i59.94, etc. when the input is supported by the monitor.

5.2.4 System

The **system** menu provides calibration, language selection, firmware update, LUT file loading and factory reset operations, as shown in Figure 5.2-9:



Figure 5.2-9 System Menu

Table 5.2-5 Description of System Menu Items

Menu	Items	Default	Domain Range	Description
CALIBRATION LUT	COLOR TEMP	NATIVE	NATIVE/ D56/D65 /D93/ USER	Select a calibration standard for the panel
	GAMMA	2.2	2.2/2.4	Set Gamma
	CALIBRATION	ON	ON/OFF	Enable/disable calibration

Menu	Items	Default	Domain Range	Description
	LUT			LUT
	BRIGHTNESS	50	0~100	Adjust the brightness
	SATURATION	50	0~100	Adjust the saturation
	R-GAIN	512	0~512	Adjust the Red Gain
	G-GAIN	512	0~512	Adjust the Green Gain
	B-GAIN	512	0~512	Adjust the Blue Gain
	RGB GAIN RESET	--	--	Reset R,G,B GAIN
	COLOR FROM	D65	D56/D65 /D93	Copy this parameter value to USER
	INPUT LEVELS	VIDEO	VIDEO: 64~940 FULL: 0~1023	Set color range
LANGUAGE	OPTIONS	中文	ENGLISH / 中文 / Français / Español	Select a language mode
MONITOR INFO	VERSION	--	--	Show the firmware versions
	SERIAL NUMBER	--	--	Show serial number
	MODEL	--	--	Show device model
FIRMWARE UPDATE	EXECUTE FIRMWARE UPDATE	--	--	Execute firmware update
LOAD LUT FILE	EXECUTE LOAD LUT	--	--	Load a color look profile from SD card

Menu	Items	Default	Domain Range	Description
	FILE			
FACTORY RESET	EXECUTE FACTORY RESET	--	--	Revert the factory settings
	LOGO DISPLAY	ON	OFF/ON	Enable/disable display LOGO

1. Enable/Disable Calibration

Set **system** → **CALIBRATION LUT** item to display the CALIBRATION menu, as shown in Figure 5.2-10:



Figure 5.2-10 Calibration LUT Menu

Set **system** → **CALIBRATION LUT** → **CALIBRATION LUT** item as **ON**, it will be able to load LUT file.

Set **system** → **CALIBRATION LUT** → **CALIBRATION LUT** item as **OFF**, it will be disable to load LUT file.

2. Load LUT File

First, write the designated LUT file to the monitor.

Operation: Select **system** → **LOAD LUT FILE** → **EXECUTE LOAD LUT FILE** item to choose a LUT file from SD card.

Scroll the joystick right to display the LUT file list menu, as shown in Figure 5.2-11, scroll up or down to select a LUT type as **USER LUT**, **CAMERA LUT** or **CALIBRATION LUT**, and press the joystick straight down to confirm the selection. Then, it will pop up a series of directories for navigating to the designated LUT file, scroll up or down to select the LUT file with .cube suffix, and specify its storage directory, as shown in Figure 5.2-12, please don't cut off the power during loading.



Figure 5.2-11 Calibration LUT Directory

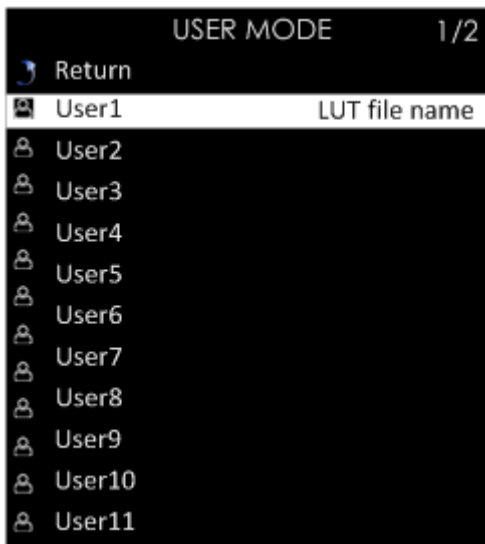

Figure 5.2-12 LUT Storage Directory

For example: Load a LUT file to **USER LUT**, it will prompt a directory for LUT file selection, then select a LUT and choose a target **USER LUT** to be stored, as shown in Figure 5.2-12. For example, select **USER1**, press the joystick straight down to confirm the selection, it will write the specified LUT file into the monitor from the SD card.

Second, use **LOOK** tool to activate a LUT to current scene.

Operation: scroll the joystick right to access a scene, and add a **LOOK** tool for the scene, for example, set the **ENABLE** item as **ON**, **SETTING** item as **USER**, and **USER LUT** as **USER1**, thus, it will apply **USER1** to current scene display. After activating a LUT file, it will be loaded to the image display immediately, as shown in Figure 5.2-13:



Figure 5.2-13 Output Image Applied with a LUT File

Tips

- Make sure to restart the device to effect the selected user LUT file after loading it to a designated LUT directory through the SD card.
- There will a “File format not support!” prompt for unavailable LUT file when executing file writing operation.
- The items about RED/GREEN/BLUE GAIN are available only in USER mode. If the COLOR TEMP sets as **USER** with customized settings, you can select the menu item **RGB GAIN RESET** command to restore original values for Gains.
- Refer to “6.1.4 Look Tools” for the details about loading the 3D LUT file.
- The SD card should be formatted to FAT32, and it's recommended to use SD cards that are 16G (or under).

If detecting no SD card occurs during the operation, it will prompt “**SD Card does not exist!**”; if any other wrong happened, it will pop up the relevant prompt.

3. BRIGHTNESS

Set **system** → **CALIBRATION** → **BRIGHTNESS** item to adjust the brightness. Scroll left to decrease the brightness, or scroll right to increase the brightness.

4. R/G/B GAIN

Set **system**→ **CALIBRATION** →**R-GAIN/G-GAIN/B-GAIN** item to adjust the gain values. Scroll left to decrease the gain, or scroll right to increase the gain.

5. FIRMWARE UPDATE

Select **system**→ **FIRMWARE UPDATE**→**EXECUTE FIRMWARE UPDATE** item to upgrade the firmware, it will prompt as shown in Figure 5.2-14:

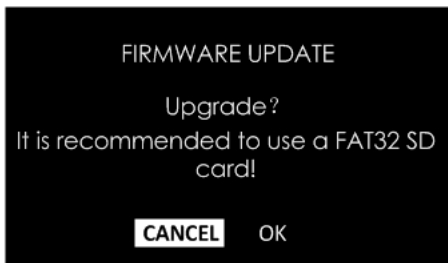

Figure 5.2-14 FIRMWARE UPDATE

Scroll right to select **OK** command, and press the joystick straight down to confirm the selection. It will update the firmware from the SD card.

6. FACTORY RESET

Select **system**→ **FACTORY RESET**→ **EXECUTE FACTORY RESET** item to initialize the settings to default values, it will pop up a prompt, as shown in Figure 5.2-15 , scroll right to select **RESET** command, and press the joystick straight down to confirm the selection.

Please pay some patience during the reset operation, and it lasts about one minute. The device will be in black screen mode for a short time after confirming reset operation, and then it will display the Boot Screen for successful reset operation, as shown in Figure 5.2-16. At last, please restart the device by manual.



Figure 5.2-15 *Prompt for Factory Reset*



Figure 5.2-16 *Boot Screen*

Tips

- It lasts about one minute for restarting operation, please don't do any operations during restarting the device.

Chapter 6 Scenes and Tools

6.1 Scenes Tools Settings

You can create customized scene pages with different features and settings in G7 4K ULTRAHD. In a scene, press the joystick straight down, and select **ADD NEW TOOL** command, and press the joystick straight down again, it will display the Tools Menu, as shown in Figure 6.1-1.

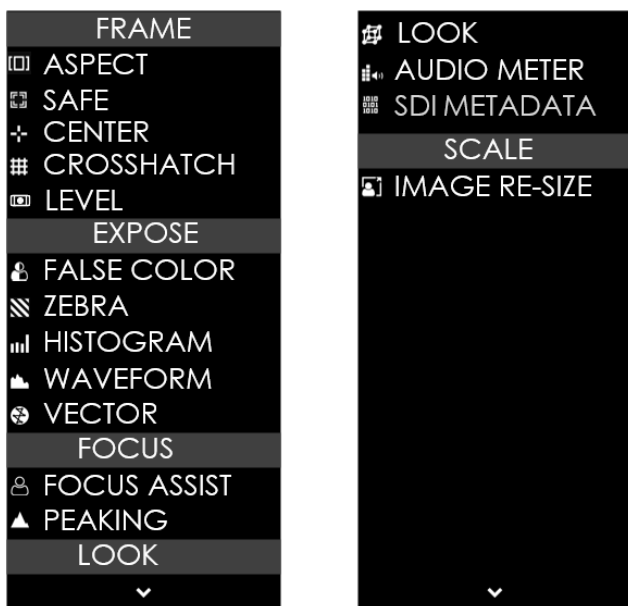

Figure 6.1-1 Tools Menu for Scene

The tools menu provides access to tools aiding in composition, focus and exposure for a scene, you can add several tools on a scene, and then they will be listed in a tool bar, as shown in Figure 6.1-2. After adding tools

to the tool bar of a scene, you can edit the tool's attributes by its tool settings menu, as shown in Figure 6.1-3:



Figure 6.1-2 Tool Bar for A Scene



Figure 6.1-3 Tool Settings Menu

It will introduce the tools and their attributes in the following section, and refer to “6.2 Tools Operations” for the details about tools operation.

6.1.1 Frame Tools

Frame tools assist to set viewing frame, including aspect area, safe area, center and crosshatch. Show or hide these markers by their switches easily, and their display style and transparency are adjustable.



Figure 6.1-4 Frame Tools

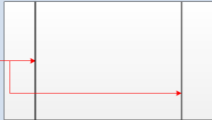
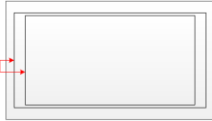

Table 6.1-1 Description of Frame Tools

Tool	Items	Default	Domain Range	Description
ASPECT	ENABLE	OFF	OFF/ON	Enable/Disable area marker display
	RATIO	4:3	4:3/1.85:1/ 2.39:1 /16:9/9:16/ 3:4/4:5/ CUSTOM	Select the marker type
	WIDTH	75	25~100	Set the width of the mat area in CUSTOM mode
	HEIGHT	75	25~100	Set the height of the mat area in CUSTOM mode
	SETTING	MATTE	MATTE/ LINE	Set the mat area type is 50% darken area or line

Tool	Items	Default	Domain Range	Description
SAFE	ENABLE	OFF	OFF/ON	Enable/Disable safe marker display
	FORMAT	16:9	16:9/14:9/4:3	Set the safe marker position
	ACTION	OFF	OFF/ON	The safe marker is displayed as an outside frame, proportional to 92% of the FORMAT
	TITLE	OFF	OFF/ON	The safe marker is displayed as an inside frame, proportional to 80% of the FORMAT in horizontal direction, and 90% of the FORMAT in vertical direction.
CENTER	ENABLE	OFF	OFF/ON	Enable/Disable crosshair display
CROSSHATCH	ENABLE	OFF	OFF/ON	Enable/Disable crosshatch display
	REGIONS	2	2~9	Set the cross line number
LEVEL	ENABLE	OFF	OFF/ON	Enable/Disable the level
	CALIBRATION	--	--	Set the level reference for level calibration
	SENSITIVITY	1	1~4	Set the sensitivity for horizontal detecting. Smaller value represents more sensitive detection.

1. Marker

Marker	Illustration	Description
--------	--------------	-------------

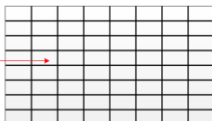
Marker	Illustration	Description
ASPECT (AREA MARKER)		This marker identifies an area with a specified aspect ratio.
SAFETY MARKER		This marker displays a rectangle to identify the safety area with a specified percentage in Area Marker.
CENTER MARKER		This marker enables easier checking the center portion's focus.
CROSS HATCH		This marker displays multiple vertical and horizontal lines to help when users check the composition of a picture.

2. Area Marker

Set the area marker **FRAME→ASPECT SAFE→RATIO** item as **CUSTOM**, the **WIDTH** and the **HEIGHT** of the marker are adjustable as your requirement.

And the outside area of the area maker could be filled with **FRAME→ASPECT SAFE →SETTING** selection, you can choose it as **MATTE** or **LINE**.

- LINE:** there are two white lines labeled the area marker;
- MATTE:** the outside area of marker is 50% blackness of the background, and without lines, as shown in Figure 6.1-5:



STYLE=LINE



STYLE=MATTE

Figure 6.1-5 Marker Mat Style

3. Level Calibration

Set **LEVEL→ENABLE** item as **ON**, and **LEVEL→ SENSITIVITY** item to a proper numeric, the lower the level sensitivity is, the more sensitive the detection is.

There will be a level indicator displayed at the bottom of the screen, as shown in Figure 6.1-6 or Figure 6.1-7. The bubble in the level will be in green when the level indicates the horizontal center, and it will be in yellow when indicates a left or right offset, and it will be in red when the bubble is very closed to the leftmost or rightmost that indicates too much askew, as shown in Figure 6.1-7.

Then, set **LEVEL→ CALIBRATION** item, it will pop up a prompt for starting level calibrating, as shown in Figure 6.1-8:



Figure 6.1-6 Level Bubble

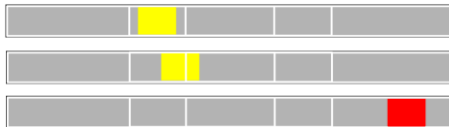

Figure 6.1-7 Level Bubbles

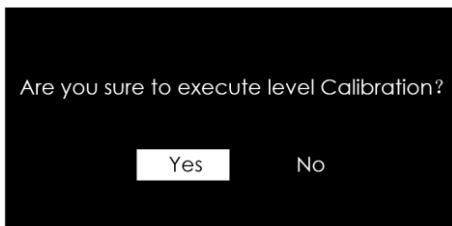

Figure 6.1-8 Level Calibration Prompt

Click **Yes** to execute level calibration which will set the current horizontal of the camera monitor to be the level reference, otherwise, click **No** to quit the calibration.

The horizontal will be recorded, and you can see the level indicator changes into green to indicate it as the level reference, then use this OSEE monitor as a level to calibrate your cameras or other recorders in order to synchronize them all with the same horizontal level.

6.1.2 Expose Tools

Expose tools provide false color, zebra, histogram, waveform and vectorscope, as shown in Figure 6.1-9:



Figure 6.1-9 Expose Tools

Table 6.1-2 Description of Expose Tools

Tool	Items	Default	Domain Range	Description
FALSE COLOR	ENABLE	OFF	OFF/ON	Enable/Disable false color function
	SETTING	Spectrum	Ref Table 6.1-3	Set the type of the false color display
ZEBRA	ENABLE	OFF	OFF/ON	Enable/Disable the zebra function that will compare the signal luminance with the ZEBRA LEVEL, and fill the relevant image area where signal luminance is higher than the ZEBRA LEVEL with a zebra pattern.
	LEVEL	50	0~100	Set the reference level for detecting luminance.
HISTOGRAM	ENABLE	OFF	OFF/ON	Enable/Disable histogram display
	SETTING	LUMA	LUMA: luminance histogram RGB: RGB histogram	Set the type of the histogram
	LOCATION	TOP RIGHT	Ref Table 6.1-4	Set the position of the histogram
	OPACITY	0	0: 100% 1: 75% 2: 50% 3: 25%	Set the transparency of the histogram
WAVEFORM	ENABLE	OFF	OFF/ON	Enable/Disable waveform display
	SETTING	LUMA	LUMA/RGB/	Set the type of the waveform

Tool	Items	Default	Domain Range	Description
			PARADE	
	SIZE	SMALL	SMALL/ MIDDLE/ LARGE	Set the size of the waveform
	LOCATION	TOP RIGHT	Ref Table 6.1-4	Set the position of the waveform
	OPACITY	0	0 ~ 3	Set the transparency of the waveform
VECTOR	ENABLE	OFF	OFF/ON	Enable/Disable vectorscope display
	LOCATION	TOP RIGHT	Ref Table 6.1-4	Set the position of the vectorscope
	OPACITY	0	0~3	Set the transparency of the vectorscope

1. FALSE COLOR

EXPOSURE ASSIST is also known as FALSE COLOR, this function generates an artificial luminance map of the input signal. This is a quick way to gauge the exposure levels of an image in a clear way.

Add the **FLASE COLOR** tool to the current scene, and activate the FALSE COLOR tool. It provides various types of FALSE COLOR as below:

Table 6.1-3 FALSE COLOR TYPES

FALSE COLOR TYPES	
Spectrum	BMD
SONY SLOG3	BMD 4K
SONY SLOG2	ARRI REC709

FALSE COLOR TYPES	
ARRI LOGC	SONY LC709A
CANON CLOG2	SONY LC709
CANON CLOG3	PANASONIC V709
PANASONIC VLOG	RED RG3
RED LOG FILM	RED RG4
RED RL3G10	

For example: Set **FALSE COLOR** → **ENABLE** item as **ON**, set **FALSE COLOR** → **SETTING** item as **ARRI LogC**, as shown in Figure 6.1-10:



FALSE COLOR=OFF



FALSE COLOR=ON

Figure 6.1-10 Comparison Mode- Original Image and Normal Mode Image

Tips

- The LOOK tool is incompatible with the False Color tool. That is, enable the LOOK tool, the False Color tool will be disabled automatically, and enable the False Color tool, the LOOK tool will be disabled automatically.

2. ZEBRA

The **ZEBRA** function is used to display images on the screen with a zebra pattern to adjust the camera exposure parameter. It will compare the signal luminance with the **ZEBRA LEVEL**, and fill the relevant image area where signal luminance is higher than the **ZEBRA LEVEL** with a zebra pattern

For example, set the **ZEBRA LEVEL** as 80, the compared results are as shown in Figure 6.1-11, the special area is filled with a zebra pattern.



ORIGINAL IMAGE



ZEBRA CHECK

Figure 6.1-11 Illustration for ZEBRA Function

3. HISTOGRAM

Histogram assists in judging the distribution of luminance in the image.

■ Histogram Type

Set **EXPOSE**→**HISTOGRAM**→**SETTING** item as LUMA or RGB, these two histogram types are as shown in Figure 6.1-12:

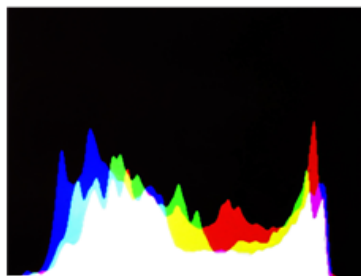

STYLE=RGB



STYLE=LUMA

Figure 6.1-12 RGB Histogram and LUMA Histogram

4. WAVEFORM

■ WAVEFORM SIZE

Set **EXPOSE**→**WAVEFORM**→**SIZE** item to adjust the size of the waveform, there are three kinds of sizes for waveform:

- Small size waveform: set **SIZE** item as **SMALL**, and this kind of waveform could be located in any one of the 8 positions listed in **LOCATION** item;
- 75% waveform: set **SIZE** item as **MIDDLE**, and this kind of waveform is located in the center bottom of the screen, and it can't be moved;
- Full size waveform: set **SIZE** item as **LARGE**, and this kind of waveform is located in the bottom of the screen, and it can't be moved.

■ WAVEFORM TYPE

Set **EXPOSE**→**WAVEFORM**→**STYLE** item to display the following three kinds of waveform as LUMA, RGB, PARADE, as shown in Figure 6.1-13:

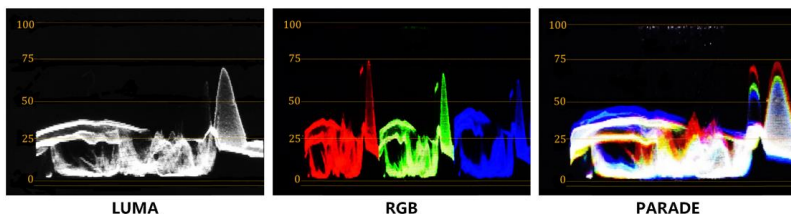

Figure 6.1-13 *LUMA Waveform and RGB Waveform and PARADE Waveform*

5. VECTORSCOPE

Set **EXPOSE**→**VECTOR**→**ENABLE** item to display or hide the vectorscope.

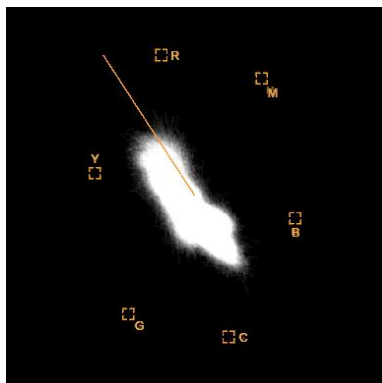

Figure 6.1-14 *VECTORSCOPE*

6. LOCATION

There are 8 positions for display the histogram, waveform and vectorscope on the screen, as shown in Table 6.1-4 and Figure 6.1-15. Move them through the **LOCATION** item.

Table 6.1-4 *LOCATION SETTINGS*

Locations	
TOP RIGHT	BOTTOM LEFT
MIDDLE RIGHT	MIDDLE LEFT
BOTTOM RIGHT	TOP LEFT
MIDDLE BOTTOM	TOP MIDDLE

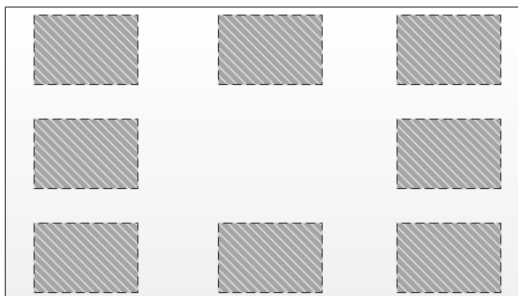

Figure 6.1-15 Location of the Assistant Elements

7. OPACITY

There are 4 degrees of opacity for display the histogram, waveform and vectorscope on the screen. Set the transparency through the **OPACITY** item.

- 0: 100%, when opacity set to 0, the assistant element (histogram, waveform or vectorscope) is opaque, not transparent.
- 1: 75%, when opacity set to 1, the assistant element (histogram, waveform or vectorscope) is proportional to 75% opacity.
- 2: 50%, when opacity set to 2, the assistant element (histogram, waveform or vectorscope) is proportional to 50% opacity.

- 3: 25%, when opacity set to 3, the assistant element (histogram, waveform or vectorscope) is proportional to 25% opacity.

For example: set **EXPOSE**→**HISTOGRAM**→ **OPACITY** as 0, 1, 2, 3 separately, the comparison are as below:

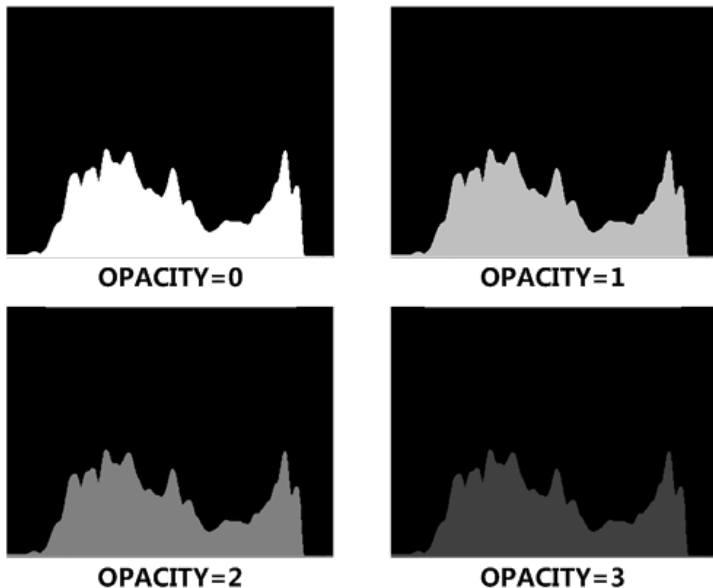

Figure 6.1-16 Different Opacity for Histogram

6.1.3 Focus Tools

Focus tools provide the focus assist function and the peaking function. Set display color, sensitivity and display type for focus assist, and set intensity for peaking detecting.



Figure 6.1-17 Focus Tools

Table 6.1-5 Description of Focus Tools

Tool	Items	Default	Domain Range	Description
FOCUS ASSIST	ENABLE	OFF	OFF/ON	Enable/Disable focus assist function
	COLOR	RED	STANDARD /RED /GREEN /BLUE	Select the color of the focus assist edge. For standard color, the intensified edges highlight in white.
	SENSITIVITY	5	1 ~ 10	Set the edge difference value between the edges in an image, and take this value as the reference value. Larger value means more detail detection.
	B&W BACKGRO UND	OFF	OFF: COLOR MODE ON: BLACK & WHITE MODE	Set the Focus Assist display mode: color mode or black&white mode.
PEAKING	ENABLE	OFF	OFF/ON	Enable/Disable peaking function Over sharpen the image.
	INTENSITY	5	1 ~ 10	Set the sharpness level of the image. The higher the value, the sharper the image.

1. FOCUS ASSIST

The FOCUS ASSIST function is used to display images on the screen with intensified edge to help camera focus operation. The intensified edges are those areas whose difference value exceeds the reference focus level (**SENSITIVITY**), and the intensified edge are displayed in the designated color set by **COLOR**.

■ FOCUS ASSIST MODE

- **COLOR MODE:** Set **FOCUS** → **FOCUS ASSIST** → **B&W BACKGROUND** item as **OFF**, the image is in color mode, then set **FOCUS** → **FOCUS ASSIST** → **COLOR** to color the intensified edge.
- **B&W MODE:** Set **FOCUS** → **FOCUS ASSIST** → **B&W BACKGROUND** item as **ON**, the image is in black and white mode, that is removing all colors and only leaving the luminance data of the signal.



**B&W BACKGROUND=OFF
COLOR=RED**



**B&W BACKGROUND=OFF
COLOR=GREEN**

Figure 6.1-18 Illustration for FOCUS ASSIST Function

**B&W BACKGROUND=ON***Figure 6.1-19 Illustration for FOCUS ASSIST Function*

6.1.4 Look Tools

Look tools provides loading 3D LUT profile and adding audio meter to current scene, as shown in Figure 6.1-20

*Figure 6.1-20 Look Tools**Table 6.1-6 Description of Look Tools*

Tool	Items	Default	Domain Range	Description
LOOK	ENABLE	OFF	OFF/ON	Enable/Disable LUT profile function
	SETTING	CAMERA	CAMERA/ USER	Select the LUT type
	CAMERA LUT	ARRI_LogC _Rec709	Ref Table 6.1-7	Select a camera LUT

Tool	Items	Default	Domain Range	Description
	USER LUT	User1	User1 ~ User16	Select a user LUT
	USER LUT NAME	--	--	Display the user LUT name
AUDIO METER	ENABLE	OFF	OFF/ON	Enable/Disable audio meter display
	LOCATION	BOT LEFT	BOT LEFT/ BOT RIGHT	Set the position of the audio meter
	OPACITY	0	0~3	Set the transparency of the audio meter

1. LOOK PROFILE (3D LUT)

The monitor is equipped with various color lookup profiles for different requirements. We provide the following LUT profiles:

- CAMERA LUT: preset camera logs**, as shown in Table 6.1-7;
- USER LUT**: custom 3D LUTs from SD card.

Select **LOOK**→ **LOOK**→ **CAMERA LUT** item to choose a 3D LUT file from SD card or internal files.

■ Preset LUT File(CAMERA LUT)

There are versatile preset 3D-LUT tables, supporting the LUT files for ARRI, RED, SONY, Panasonic, Canon, BlackMagic and Panavision, etc.

Table 6.1-7 CAMERA LUT Files

Preset LUT File	Company
ARRI_LogC_Rec709	ARRI

Preset LUT File	Company
BMD_4.6KFilm_Rec709	BlackMagic
BMD_4.6KFilmV3_Rec709	
BMD_4KFilm_Rec709	
BMD_4KFilmV2_Rec709	
BMD_4KFilmV3_Rec709	
BMD_CCFilm_Rec709	
BMD_CCFilmV2_Rec709	
Canon_CLog1Cine_Rec709_FF_V1.1	Canon
Canon_CLog2Cine_Rec709_FF_V1.1	
Canon_CLog3Cine_Rec709_FF_V1.1	
DJI_Phantom3DLog_Rec709_Improv	DJI
DJI_Phantom4DLog_Rec709	
DJI_Phantom4Dlog_Rec709_Improv	
DJI_X5DLog_Rec709_Improv	
FUJI_FLogFGamut_FLogRec709_V1	FUJIFILM
FUJI_FLogFGamut_WDRRec709_V1	
GoPro_Protune_Rec709	GoPro
JVC_JLog1_Rec709_Daylight	JVC
JVC_JLog1_Rec709_Tungsten	
Panasonic_VLog_V709_V1	Panasonic
RED_L3G10RWG_Rec709_R1_V1.13	RED
RED_L3G10RWG_Rec709_R2_V1.13	
RED_L3G10RWG_Rec709_R3_V1.13	

Preset LUT File	Company
RED_L3G10RWG_Rec709_R4_V1.13	
RED_RedLogFilm_RG3	
Sony_SLog2SGamut_LC709	Sony
Sony_SLog2SGamut_LC709A	
Sony_SLog3SG3Cine_LC709	
Sony_SLog3SG3Cine_LC709A	

Tips

- The preset LUT files are constantly under development.
- G7 4K ULTRAHD supports color management software CalMAN currently, the customized 3D LUT profiles(*.cube) produced by these software could be loaded to SD card by a control computer.
- The LOOK tool is incompatible with the False Color(EXPOSURE ASSIST) tool. That is, enable the LOOK tool, the False Color tool will be disabled automatically, and enable the False Color tool, the LOOK tool will be disabled automatically.
- The SD card should be formatted to FAT32, and it's recommended to use SD cards that are 16G (or under).

2. AUDIO METER

Set **LOOK→AUDIO METER→ENABLE** item as ON to enable the display of Audio Meter on screen.

The audio meter could be displayed at the left bottom or right bottom of the screen, and the opacity could be set from 0 to 3. Refer to “6.1.2 Expose Tools--7 OPACITY” for the details about OPACITY.

The volume in normal range appears in green, above -20dB but below -10dB appears in yellow, and above -10dB appears in red, as shown in Figure 6.1-21:



Figure 6.1-21 Audio Meter

6.1.5 Scale Tools

Scale tool is used to adjust the size and position of the screen, as shown in Figure 6.1-22



Figure 6.1-22 Scale Tools

Table 6.1-8 Description of Scale Tools

Tool	Items	Default	Domain Range	Description
IMAGE RE-SIZE	ENABLE	OFF	OFF/ON	Enable/Disable image scale function
	LOACTION	TOP LIGHT	TOP RIGHT MID RIGHT BOT RIGHT MID BOT BOT LEFT MID LEFT TOP LEFT TOP MID CENTER	Set image position on screen

1. IMAGE SCALE

■ **Activate Image Scale Function**

Set **SCALE**→ **SCALE**→ **ENABLE** item as **ON**, the image scale is activated. The image size changes to 75% of the original one, and after scaling down, the blank area will be filled with black, as shown in Figure 6.1-23:



Figure 6.1-23 Scale Illustration

■ **Image Position**

There are 9 positions for display the small image on screen, they are TOP RIGHT, MIDDLE RIGHT, BOTTOM RIGHT, MIDDLE BOTTOM, BOTTOM LEFT, MIDDLE LEFT, TOP LEFT, TOP MIDDLE and CENTER, as shown in Figure 6.1-24. Move it through the **LOCATION** item.

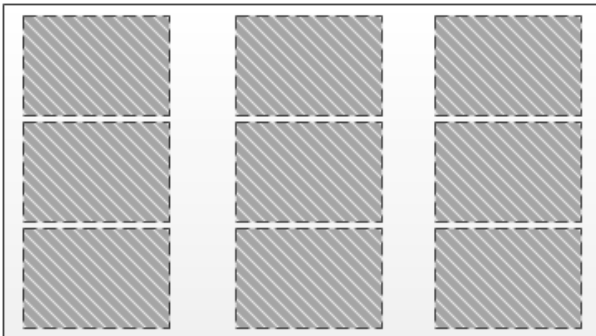



Figure 6.1-24 Image Position

6.2 Tools Operations

This chapter will introduce how to edit scene and its tools in this section.

6.2.1 Add a Scene

You can customize up to 8 scenes in G7 4K ULTRAHD for various requirements, and switch swiftly among these scenes by joystick operations.

Scroll the joystick right and hold for 3 seconds to add a new scene, it will prompt “**Add New MySet** ” command in the bottom center of the screen, as shown in Figure 6.2-1, press the joystick straight down to confirm the operation.

The scene will be numbered in sequence, and the name (a scene icon followed by a number) will be displayed at the bottom center of the tool bar, as shown in Figure 6.2-2:

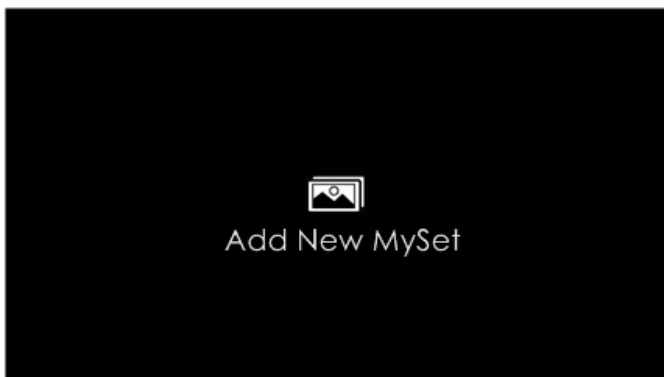
*Figure 6.2-1 Add New MySet*

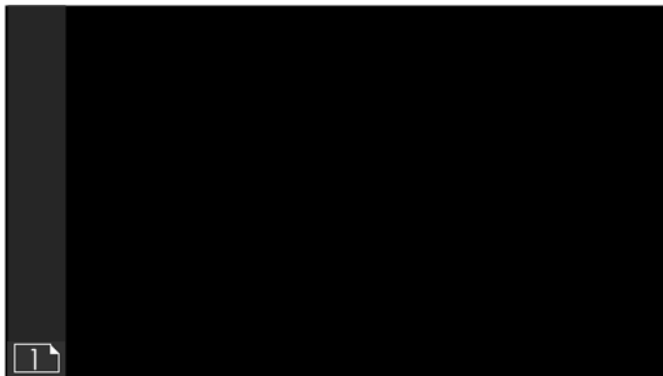

Figure 6.2-2 A New Scene

Tips

- G7 4K ULTRAHD supports up to 8 customized scenes.
- No.1 scene exists by default.

Scroll the joystick left or right to switch among scenes.

6.2.2 Delete a Scene

Scroll the joystick down and hold for 3 seconds in a scene that's not Scene 1, it will display the **DELETE** command at the bottom of the screen, as shown in Figure 6.2-3. Press the joystick straight down to confirm deletion, and there will be a waiting prompt during the deletion. Wait until the prompt disappeared, then the scene deletion is completed.



Figure 6.2-3 Prompt for Delete a Scene

Tips

- No.1 scene can't be deleted.
-

6.2.3 Add a Tool

After creating a scene, add some tools to assist monitoring, for example, add a marker, waveform, histogram or audio meter, etc.

Tips

- Each scene supports up to 8 scene tools.
 - You can add more than one of the same tool in a scene.
-

Scroll the joystick down, it will pop up the “**ADD NEW TOOL**” command, as shown in Figure 6.2-4. Press the joystick straight down to confirm, and it will pop up the **Tools Menu** on screen, as shown in Figure 6.2-5:



Figure 6.2-4 Add a New Tool



Figure 6.2-5 Tools Menu for Scene

Scroll the joystick up or down to select your desired scene tool, and press the joystick straight down to confirm, the selected tool will be added to the **Tool Bar** of the current scene.

For example: Add histogram to Tool Bar

Scroll the joystick up or down to select **HISTORGRAM** item, as shown in Figure 6.2-6, press the joystick straight down to confirm the selection, the **HISTORGRAM**, tool will be added in the tool bar, as shown in Figure 6.2-7:



Figure 6.2-6 Choose Histogram Tool



Figure 6.2-7 Histogram in the Tool Bar

Continue to add other tools for the scene, and you can add up to 8 tools in a scene.

6.2.4 Load/Close Tool Bar

In a scene, after adding the tools, you can load the tool bar or close the tool bar. The instructions are as below:

■ Load Tool Bar

First, scroll the joystick left or right to access a scene you want to use;

Second, press the joystick straight down to load the tool bar for the current scene, the tool bar will be displayed at the leftmost of the screen, as shown in Figure 6.2-8. The bar labeled in the red rectangle are the tool bar for the current scene.



Figure 6.2-8 Tool Bar for A Scene

■ Close Tool Bar

- After loading a tool bar, scroll the joystick left to close the tool bar. The closed empty tool bar will completely disappear after 3 seconds.

- When in editing tool setting menu status, scroll the joystick left to return to the previous menu, then scroll the joystick left to close the tool bar.

■ Open tool setting menu

After loading a tool bar, scroll the joystick right to access tool settings menu, as shown in Figure 6.2-9



Figure 6.2-9 Tool Setting Menu

Scroll the joystick left to return to the tool bar and close the tool setting menu.

6.2.5 Open/Close a Tool

Follow the instructions below to open or close a tool swiftly:

■ Open a Tool

First, press the joystick straight down to load the tool bar of the current scene;

Second, scroll the joystick up or down to select a tool;

At last, press the joystick straight down to open the tool.

■ Close a Tool

Press the joystick straight down to close the tool after opened it.

■ Select a Tool

Scroll the joystick up or down to select a tool after loading the tool bar.

Tips

- The tool icon in the tool bar will be in green highlight under Open status, and will be in white under Close status.
-

6.2.6 Tool Settings

Add tools for a scene through the tool settings, then, set a tool's attributes by scrolling the joystick right, it will display the tool settings menu on the screen.

Scroll the joystick left or right to switch among different scenes. The tool bar is empty when switching to a scene by default. You should press the joystick straight down to display the active tool bar for the current scene.

Operate the tool bar to display each tool settings menu, and set the style, location or size of the tool. Refer to “6.1 Scenes Tools Settings” for the details of each tool.

For example: Display histogram on a scene.

In a scene, press the joystick straight down to display the tool bar at the left side of the screen. Scroll the joystick down to move the cursor onto the **HISTOGRAM** tool icon, as shown in Figure 6.2-10:



Figure 6.2-10 Select HISTOGRAM

Press the joystick straight down to load the histogram window on the screen, and the histogram icon is lit in highlight green, as shown in Figure 6.2-11. Or press the joystick straight down again to close the histogram window.



Figure 6.2-11 Display the Histogram

Scroll the joystick right to access the next level menu, it will display the

histogram settings menu, as shown in Figure 6.2-12. It lists the characteristics of histogram in this menu, such as SETTING, LOCATION, OPACITY and ENABLE switch. After finish the parameter settings, scroll the joystick left to return to the tool bar.



Figure 6.2-12 Settings Menu for Histogram

i Tips

- The parameters of the tool could not be modified until the tool is opened.

6.2.7 Delete a Tool

In a scene, press the joystick straight down to display the tool bar for current scene, and scroll the joystick up or down to select the tool you want to delete, then scroll right to access the tool setting menu, and select **DELETE** command at the end of the menu list, as shown in Figure 6.2-13.



Figure 6.2-13 Delete a Tool

Press the joystick straight down to confirm the selection, and it will pop up a prompt to confirm the deletion, as shown in Figure 6.2-14, press straight down to delete, then the tool will be deleted from its tool bar.



Figure 6.2-14 Prompt for Deleting a Tool

 **Tips**

- The effect or window displayed on the current scene will be closed after the relevant tool is deleted.
-

Chapter 7 Specifications

7.1 Product detailed information

Specification	Values
Model	G7 4K ULTRAHD
Display	
Dimension	7.0"
Aspect Ratio	16:10
Viewing Angle	160° (H)*160° (V)
Resolution	1920×1200
Contrast	1200:1
Input Signal Formats	
HDMI	2160P30/29.97/25/24/23.98
	1080P60/59.94/50/30/29.97/25/24/23.98
	1080i60/59.94/50
	720p60/59.94/50
	480P60, 576P50
SDI	2KP60/59.94/50
	1080P60/59.94/50/30/29.97/25/24/23.98
	1080i60/59.94/50
	1080SF30/29.97/25/24/23.98
	1035I60/59.94

Specification	Values		
	720P60/59.94/50/30/29.97/25/24/23.98		
Connector Type			
HDMI IN	HDMI Type A		
HDMI OUT	HDMI Type A, loop out		
SDI IN	BNC		
SDI OUT	BNC, loop out		
Audio	3.5mm Mini Jack		
Control	2.5mm Jack		
Power			
Input Voltage	DC IN 11~17VDC		
Battery Type	SONY NP-F, 6V ~ 8.4V		
Consumption	18.8W		
Environmental			
Operating Temperature	0° C~50° C		
Dimensions(Bare Monitor)	192.0(mm) × 116.3(mm) × 24.7(mm)		
Weight(without Battery)	450g		
Features			
Image Scale	Yes	Zebra	Yes
Anamorphic De-squeeze	Yes	Waveform	Yes
Image Rotate	Yes	Vectorscope	Yes
Cross Hatch	Yes	RGB Parade	Yes
Center Marker	Yes	Histogram	Yes

Specification	Values		
Safe Marker	Yes	Audio Meters	Yes
Area Marker	Yes	Pre-loaded LUTs for Cameras	Yes
Focus Assist	Yes	LUT Loaded via SD Card	Yes
Peaking	Yes	Firmware Upgrading	Yes
Pixel Zoom(2X & 4X)	Yes	Language(EN/CH)	Yes
False Color	Yes		Yes

7.2 Dimensions

The description of the G7 4K ULTRAHD dimensions are as shown in the following figures(Unit: mm):

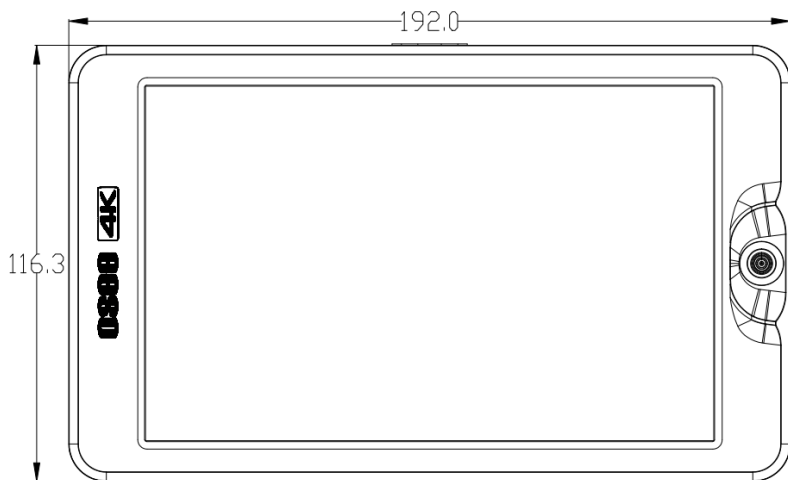

Figure 7.2-1 Front View(Unit: mm)

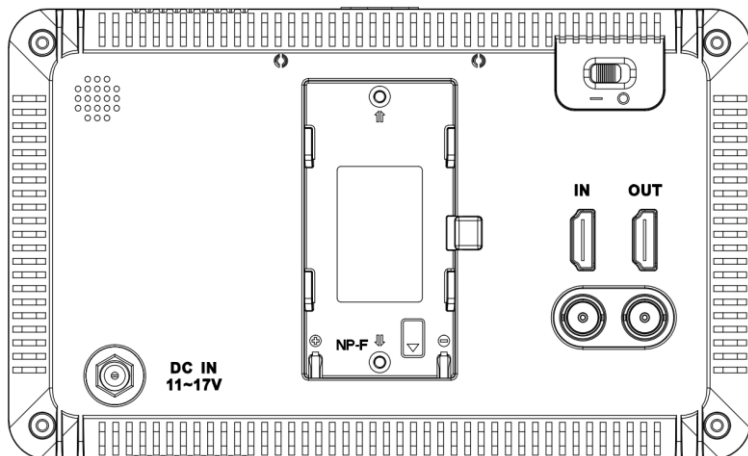

Figure 7.2-2 Back View(Unit: mm)

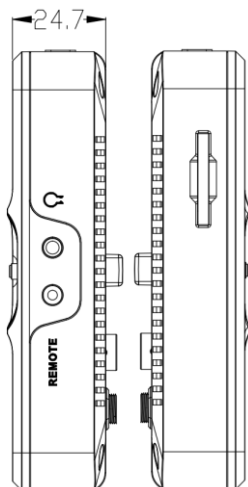

Figure 7.2-3 Side View(Unit: mm)

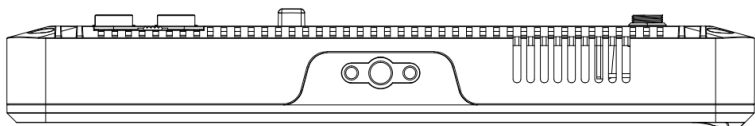

Figure 7.2-4 Top View (Unit: mm)

i Tips

- Specifications are subject to change without notice.

-----No Text Below-----



FOR MORE INFORMATION PLEASE VISIT: <http://www.osee-dig.com/>

OSEE TECHNOLOGY LTD.

Address No.22 Building, No.68 zone, Beiqing Road, Haidian District,
: Beijing, China

Tel: (+86) 010-62434168

Fax: (+86) 010-62434169